

9-Way COB Tape Connectors

Item ref: 156.646UK & 156.647UK
User Manual

Thank you for purchasing Lyyt 9-Way COB Tape Connectors.

Before starting, please ensure that you have read this instruction leaflet carefully. If you are unsure about any of the installation details, please consult a professional.

Help articles are available on our website: <https://www.avsl.com/support/article>

Description

These crimp connectors are designed to attach 8mm or 10mm wide COB LED Tape in 9 different configurations.

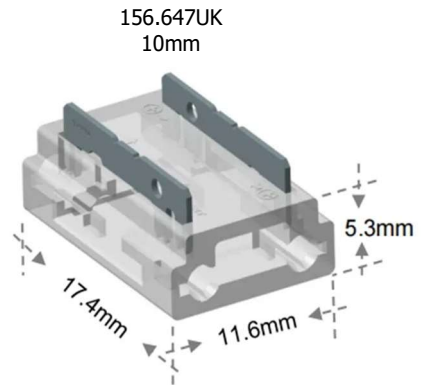
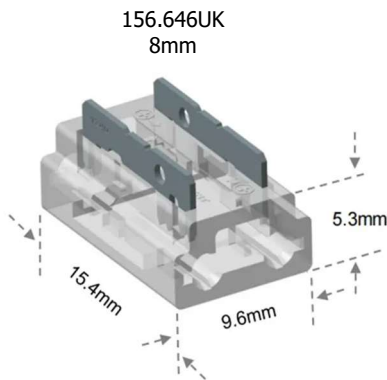

Polarity

It is important to ensure that you have correctly matched the polarity of the tape and/or DC cables before you crimp on the connector. Once you have crimped the connector, it cannot be undone. The positive polarity is clearly marked on the top of the connector:

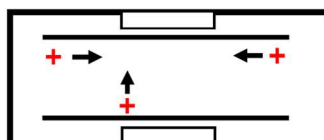

Configurations

DC to Tape

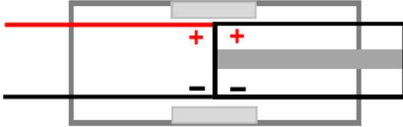

DC to DC

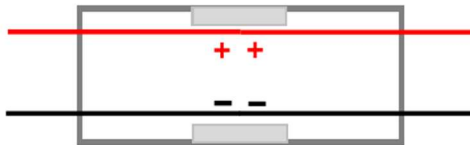

Tape to Tape

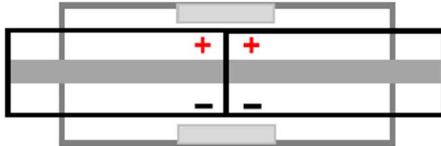

Tape to Tape 'L'

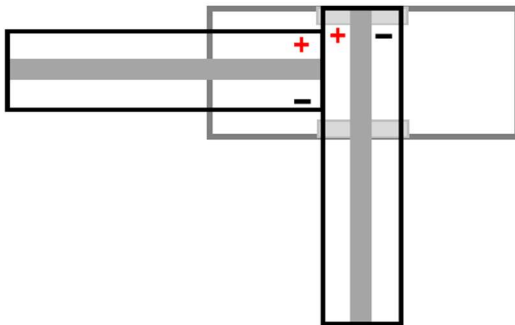

Tape to Tape & DC 'L'

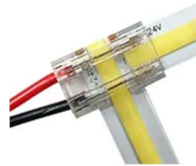
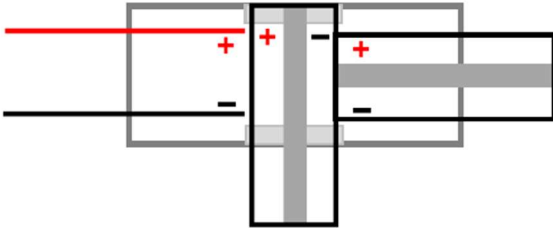

DC to 'T'

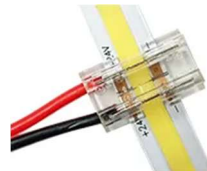
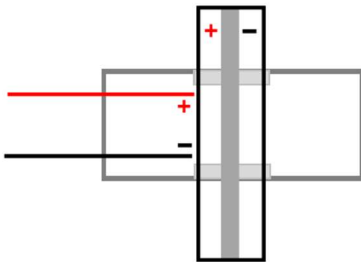

Tape to Tape 'T'

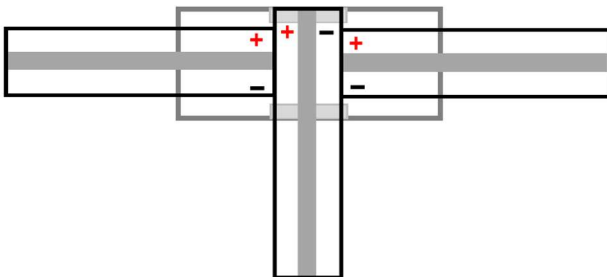

Tape to Tape & DC 'T'

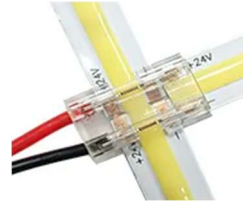
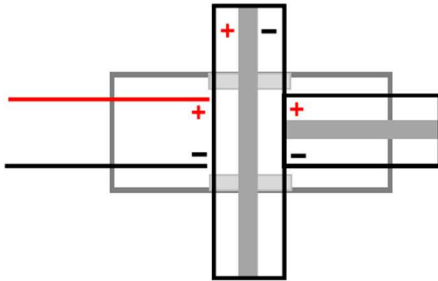

Tape to Tape 'X'

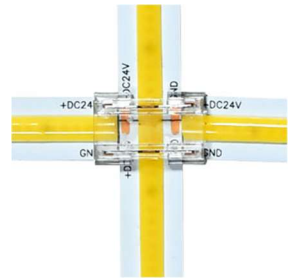
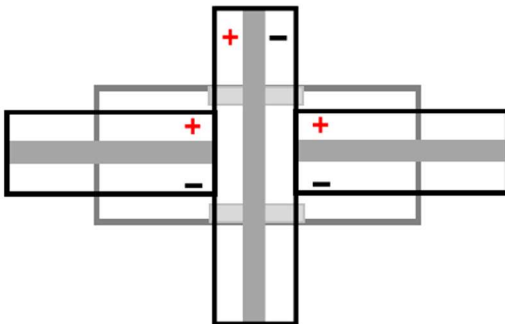

Specification

Voltage	0-36V
Max Current	5A
DC Wire Gauge	0.35 – 0.5mm ² / 20-22AWG
Operating Temperature	-10°C – 40°C
IP Rating	IP20



This product is classed as Electrical or Electronic equipment and should not be disposed with other household or commercial waste at the end of its useful life. The goods must be disposed of according to your local council guidelines.

Errors and omissions excepted.

Copyright© 2024 AVSL Group Ltd, Unit 2 Bridgewater Park, Taylor Road, Trafford Park, Manchester. M41 7JQ.

AVSL (Europe) Ltd, Unit 3D North Point House, North Point Bus. Park, New Mallow Road, Cork, Ireland